

### ICE RINK

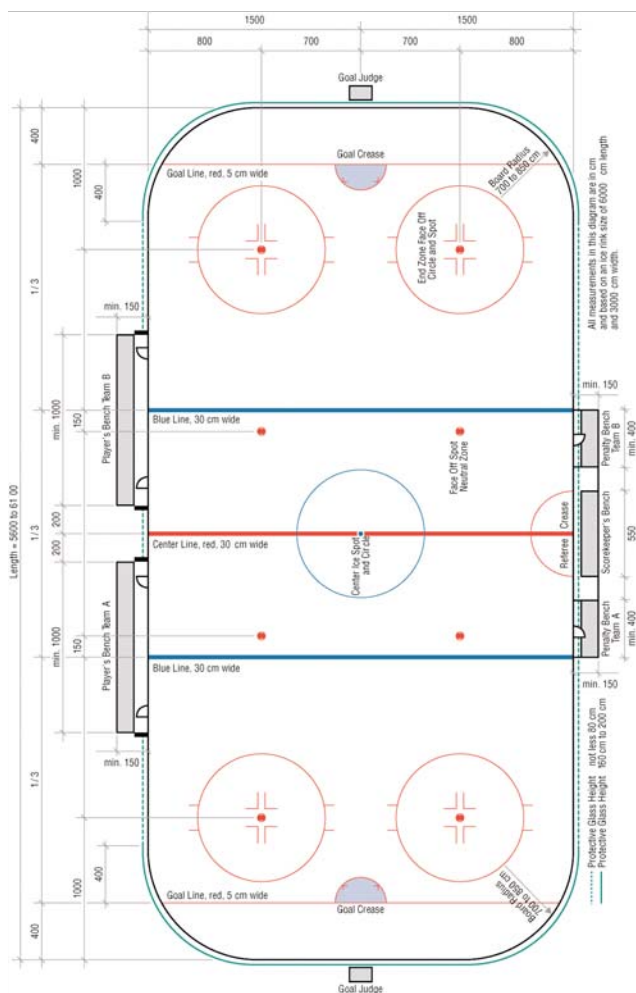

## SECTION 1 - ICE RINK

There shall be **no markings** on the ice, boards, protective glass, nets, goals, or on any surface in and around the players benches, penalty benches, goal judge benches or off-ice officials areas, except as specified under these rules or as provided in Annex 1 (Advertising regulations)

### 100 - DEFINITION OF THE RINK

The game of ice hockey shall be played on a white ice surface known as a **"Rink"**.

### 101 - DIMENSIONS OF THE RINK

Maximum size: **61 metres long by 30 metres wide.**

Minimum size: **56 metres long by 26 metres wide.**

The corners shall be rounded in the arc of a circle with a radius of **7 to 8.5 metres.**

► For IIHF competitions the size will be **60 to 61 metres long by 29 to 30 metres wide.**

### 102 - BOARDS

- The rink shall be surrounded by a wooden or plastic wall known as the **"Boards"** which shall be white in colour.
- They shall be not less than **1.17 metres** and not more than **1.22 metres in height** above the level of the ice surface.
- The boards shall be constructed in such a manner that the surface facing the ice shall be smooth and free of any obstruction that could cause injury to the players and the protective screens and gear used to hold the boards in position shall be mounted on the side away from the playing surface.
- The gaps between the panels shall be minimized to 3mm.

### 103 - KICK PLATE

At the lower part of the boards shall be fixed a **"Kick Plate"**, yellow in colour, **15 to 25 cm in height** above the ice surface level.

### 104 - DOORS

- All doors giving access to the ice surface must **swing away from the ice surface.**
- The gaps between the door and the board shall be minimized to 5 mm.

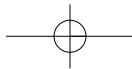

► For IIHF competitions, the protective glass and end zone nets are obligatory.

**PROTECTIVE GLASS AND BOARDS**

All measurements in cm.

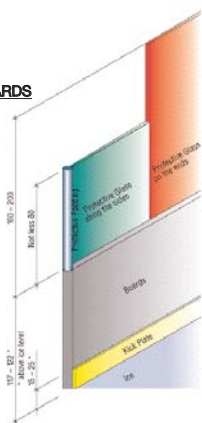

- 1. On open air rinks, all of the lines and face-off spots outlined in Rules 112 and 113 shall be marked by two lines 5 cm wide.
- 2. In case of advertising allowed on the boards, the lines shall be at least be marked on the kick plate.
- 3. The entire width of the line shall be considered as part of the zone that the puck is in.

**DIVISION OF ICE SURFACE**

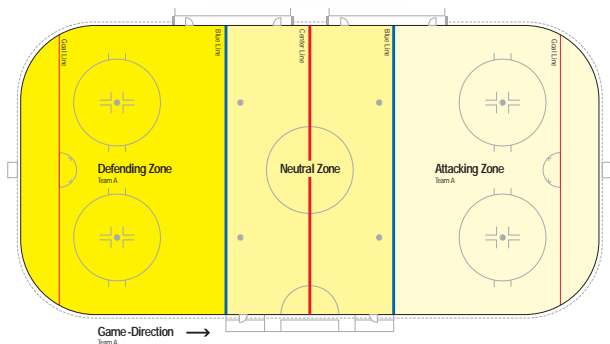

**105 - PROTECTIVE GLASS**

- a) The protective glass located above the boards shall be **160 cm to 200 cm in height** on the ends and shall extend 4 metres from the goal line towards the neutral zone and **not less than 80 cm in height** along the sides, except in front of the player benches.
- b) The gaps between the glass panels shall be minimized to 5 mm.
- c) At any interruption of the protective glass there shall be protective padding to prevent the injury of the players.
- d) No openings are allowed in the protective glass

**106 - END ZONE NETS**

Protective nets must be suspended above the end zone boards and glass.

**110 - DIVISION AND MARKING OF THE ICE SURFACE**

The ice surface shall be divided in its length by **five lines** marked on the ice and extending completely across the ice surface and continuing vertically up the boards.

**111 - GOAL LINES**

Lines shall be marked **4 metres** from each end of the ice rink, **5 cm wide** and **red** in colour, known as the **"Goal Lines"**

**112 - BLUE LINES**

- a) The ice area between the two goal lines shall be divided in three equal parts by lines 30 cm wide and blue in colour known as the **"Blue Lines"**. The Blue Lines shall extend **NEW** up the Kick Plate and onto the boards
- b) These lines shall determine the **three Zones**, defined as follows:

For one team, the zone in which their goal is situated is the:

**"Defending Zone"**

The central zone is the:

**"Neutral Zone"**

The farthest zone is the:

**"Attacking Zone"**

**113 - CENTER LINE**

A line known as the **"Center Line"** shall be located in the middle of the rink. It shall be **30 cm wide** and red in colour.

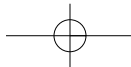

**CENTER ICE SPOT AND CIRCLE**  
All measurements in cm

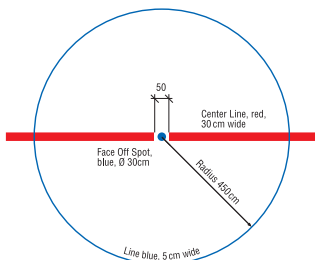

**114 - FACE-OFF SPOTS AND CIRCLES**

All spots and circles are marked on the ice surface in order to position the players for a face-off as ordered by the officials at the beginning of the game, at the beginning of each period and after each stoppage of play.

**END ZONE FACE-OFF CIRCLE AND SPOT**  
All measurements in cm

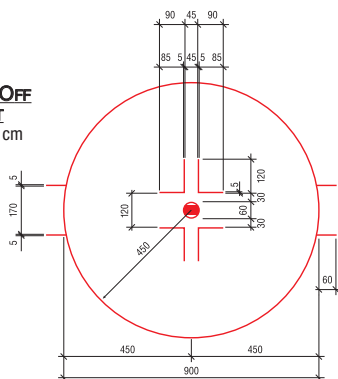

**115 - CENTER FACE-OFF SPOT AND CIRCLE**

A circular blue spot, **30 cm in diameter**, shall be marked exactly in the center of the rink. With this spot as a center, a circle with a **radius of 4.5 metres** shall be marked with a blue line **5 cm wide**.

**116 - FACE-OFF SPOTS IN NEUTRAL ZONE**

Two red spots, **60 cm in diameter**, shall be marked in the neutral zone, **1.5 metres** from each blue line as illustrated on the opposite page.

**DETAIL OF FACE-OFF SPOT**  
All measurements in cm

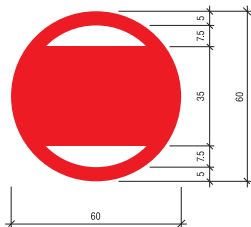

**117 - END ZONE FACE-OFF SPOTS AND CIRCLES**

- a) Face-off spots and circles shall be marked on the ice in both end zones and on both sides of each goal as illustrated on the opposite page.
- b) The face-off spots shall be **60 cm** in diameter, red in colour, as illustrated on the opposite page.
- c) On opposite sides of the end zone face-off spots shall be marked **double "L"**, as illustrated on the opposite page.
- d) The circles shall have a **radius of 4.5 metres** from the center of the face-off spots and marked with a red line, **5 cm wide**.

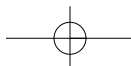

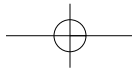

**REFEREE CREASE**  
All measurements in cm

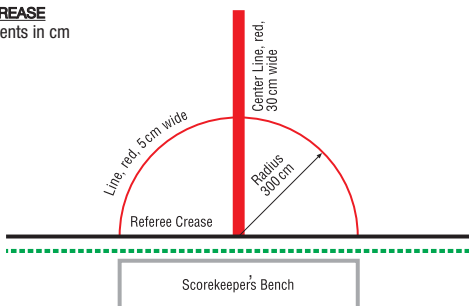

**118 - REFEREE CREASE**

An area known as the "Referee Crease" shall be marked on the ice in a semi-circle by a red line, 5 cm wide, and with a radius of 3 metres, immediately in front of the Scorekeepers Bench, as illustrated on the opposite page.

**GOAL CREASE**  
All measurements in cm

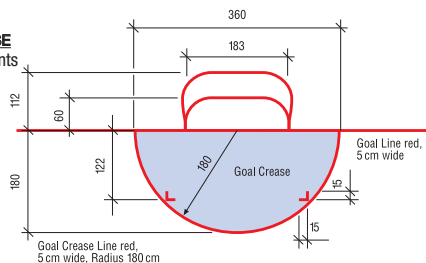

**119 - GOAL CREASE**

- a) In front of each goal a "Goal Crease" area shall be marked by a red line, 5 cm wide, as illustrated on the opposite page.
- b) The goal crease area shall be painted light blue. The inside of the goal area from the goal line to the back of the net shall be white.
- c) The goal crease shall include all the space outlined by and include the crease line and extending vertically 1.27 metres to the top of the goal frame.
- d) The goal crease shall be laid out as follows:
  1. A semi-circle 180cm in radius and 5cm in width shall be drawn using the center of the goal as the center point.
  2. In addition, an "L" shaped marking of 15cm in length (both lines) at each front corner shall be painted on the ice
  3. The location of the "L" marking is measured by drawing an imaginary line 122cm from the goal line to the edge of the semi-circle. At the point the "L" shall be drawn.

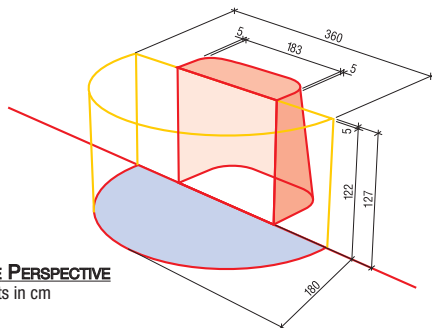

**GOAL CREASE PERSPECTIVE**  
All measurements in cm

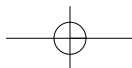



▶ 1. Goal posts and nets shall be set in such manner as to remain stationary during the progress of the game.

**NEW**

▶ 2. For the Olympic Winter Games tournaments, the IIHF World Championship, the IIHF World Women Championship, the IIHF World Championship Division I, the IIHF World Under 20 Championship and the IIHF World U18 Championship, **flexible goal pegs** are mandatory and are strongly recommended for other IIHF competitions.



▶ 1. Each player's bench must have two doors, one of which must be in the **NEUTRAL ZONE**.

▶ 2. The player benches must be protected from access by persons other than the players and the team officials.

▶ **Report** to the Proper Authorities if not so.

**PLAYERS' BENCHES AND PENALTY BENCHES**  
All measurements in cm

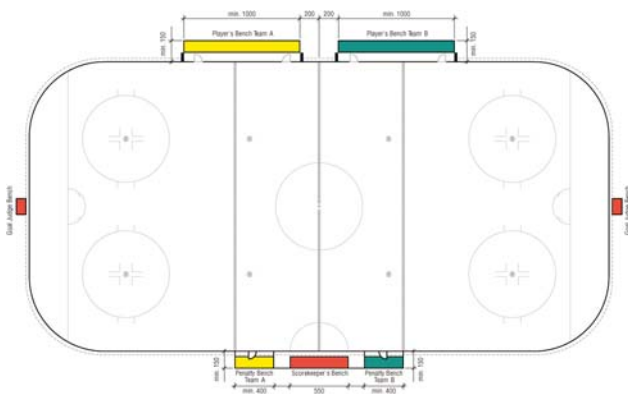

**130 - GOALS**

- a) The goals shall be located in the center of the goal lines.
- b) The goal posts shall extend vertically **1.22 metres** above the ice surface and be **1.83 metres** apart (internal measurements). The goal posts and horizontal crossbar that form the tubular steel frame shall be of a specified design with an external diameter of **5 cm** and shall be painted red.
- c) The goal posts and horizontal crossbar shall be completed by a frame supporting the netting, the deepest point of which shall not be more than **1.12 metres** or less than **0.60 metres**. It shall be painted white.
- d) A netting of white nylon cord shall be draped over to enclose the back of the goal frame in such a manner as to prevent the puck from coming to rest on the outside of it, yet strung in a manner that shall keep the puck inside the goal net.
- e) The inside parts of the supports, other than the goal posts and the crossbar, shall be covered by white padding. The padding of the base frame shall start not less than 10 cm's from the goal post and shall be attached in a manner that shall not restrict the puck from completely crossing the goal line.

**140 - PLAYERS' BENCHES**

- a) Each rink shall be provided with two identical benches, exclusively for the use of players in uniform and officials of both teams.
- b) The benches shall be on the same side of the rink, immediately along the ice but opposite to the penalty benches, separated by a substantial distance or by other facilities, and convenient to the dressing rooms.
- c) Each bench shall begin **2 metres** from the center line with a minimum length of **10 metres** and a minimum width of **1.50 metres**.
- d) Each bench shall accommodate: **16 players and 8 team officials**.

**NEW**

**141 - PENALTY BENCHES**

- a) Each rink shall be provided with two benches to be known as the penalty benches for a minimum of **5 players each**.
- b) They shall be located on both sides of the Scorekeepers desk and opposite to the player's benches and shall have minimum length of **4 metres** and a minimum width of **1.50 metres**.  
▶ Access to the penalty benches shall be restricted to persons other than the penalized players and the Penalty Bench attendants.

**142 - GOAL JUDGES' BENCHES**

Properly protected cages to eliminate interference with the Goal Judge's activities shall be placed at each end of the rink behind the board and glass in the area of the goal.

**143 - SCOREKEEPER BENCH**

Between the penalty benches shall be located the Scorekeeper Bench which shall have a length of **5.5 metres** to accommodate **6 people**.

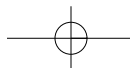

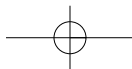

- ▶ Electronic scoreboards with videotext are recommended for IIHF competitions.
- ▶ 1. The red light shall be connected to the timing device in such a manner so that, when the period has ended, it would be impossible for the Goal Judge to turn it on.
- ▶ 2. At the end of a period, the fact that the Goal Judge is not able to turn on the red light does not necessarily mean that a goal is not valid. The determining factor is whether or not the puck is completely over the goal line and in the goal before the period ends.
- ▶ 3. The purpose of the green light is to enable the Referee and Linesmen to observe the goal and light in the same sight line and know exactly when the period ends.
- ▶ No one, except as authorised by the association concerned, shall be allowed to enter the Officials dressing room during the course of or immediately following the game. In case of an infraction to this rule report to the proper authorities.
- ▶ 1. If, in the opinion of the Referee, there is not sufficient light to continue the game, he shall have the authority to postpone the remainder of the game or a take time-out, pending improvement of the lighting situation.
- ▶ 2. If one team is handicapped to a greater extent by the failure of lights, and in the opinion of the Referee the game should not be cancelled, he shall have the authority to alternate the teams so that each team will play the same amount of time in each end of the rink.



- ▶ Music may be played during the warm-up and during any stoppage of play.

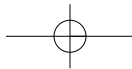

**150 - SIGNAL AND TIMING DEVICES**

**151 - SIREN**

Each rink shall be provided with a siren or other suitable sound device to be used by the Timekeeper.

**152 - CLOCK**

Each rink shall have an electric clock (scoreboard) in order to provide spectators, players and officials with accurately information concerning:

1. **Names of both teams**
2. **Time played in any period**, counting down in minutes and seconds from 20:00 to 0:00, **NEW**
3. **Penalty time remaining** to be served for at least two players on each team counting down from the total number of penalty minutes to 00:00.
4. **Score**
5. **Team time-outs**, counting down from 00:30 to 00:00 seconds.
6. **Intermission time**, counting down from 15:00 to 00:00 minutes.

**153 - RED AND GREEN LIGHTS**

Behind each goal there shall be:

1. A red light to be lit by the Goal Judge when a goal is scored,
2. A green light to be lit automatically by the electric clock when the Timekeeper **NEW** stops the clock at a stoppage of play and at the end of each period.

**160 - PLAYERS' DRESSING ROOMS**

Each team shall be provided with a suitable room with sufficient space for **30 team officials and players** and their equipment, equipped with benches, sanitary toilet and showers.

**161 - REFEREE'S AND LINESMEN DRESSING ROOM**

A separate dressing room equipped with chairs or benches, sanitary toilet and shower must be provided for the exclusive use of the Referees and Linesmen.

**170 - RINK LIGHTING**

All rinks shall be sufficiently well illuminated so that the players, officials and spectators may conveniently follow the play at all times.

**171 - SMOKING IN THE ARENA**

In enclosed rinks, smoking shall be prohibited in the playing and spectator areas, as well as in the dressing rooms and all the facilities where the players are involved.

**172 - MUSIC IN THE ARENA**

- a) **No music** shall be played while the game is in progress, or during the team time-outs. **NEW**
- b) Compressed air horns and whistles are forbidden in the ice rink.
- c) No music shall be played if and when an injured player lays on the ice at a stoppage **NEW**

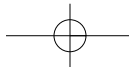

- ▶ 1. **No changes** or additions shall be permitted to the list once the game has started.
- ▶ 2. If, during the game, a team cannot place the correct number of players on the ice because of penalties or injuries, the Referee shall declare the game a **forfeit** and:
  - ▶ **Report** to the Proper Authorities.

- ▶ 1. It is not permitted to appoint a goalkeeper, Playing Coach or Manager as a Captain or Alternate Captain.
- ▶ 2. If a Captain or Alternate Captain is not on the ice, they cannot come off the bench to discuss any situation with the Referee, unless invited by the Referee. If the captain does come off the player's bench uninvited, he shall be sent back and the coach warned that a second violation shall result in a
  - ▶ **Misconduct** penalty (see Rule 572)
- ▶ 3. If both the Captain and Alternate Captain are on the ice, only the Captain has the privilege of conversing with the Referee.
- ▶ 4. Players that do not wear a "C" or "A" on their jersey shall not be granted the privileges of conversing with the Referee.

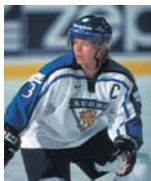

- ▶ 1. The official playing rules specify the use of protective equipment out of concern for the orderly playing of the game, and for the safety, health and welfare of participants. However, such rules do not imply a guarantee by the IIHF that the use of such equipment will provide protection from injury. It is the responsibility of the player to ensure that the equipment used conforms, where specified, with the official playing rules and is worn and maintained in good condition in accordance with the manufacturer's warranties.
- ▶ 2. For advertising and/or brand identification on the player's equipment, see Annex 1.



**PLAYER SKATE**

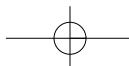

## **SECTION 2 - TEAMS, PLAYERS AND EQUIPMENT**

### **200 - PLAYERS IN UNIFORM**

- a) Before the game, the Manager or Coach of each team shall provide the Referee or Scorekeeper with a list of names and numbers of eligible players and goalkeepers, including the names of the Captain and Alternate Captains.
- b) Each team shall be allowed a maximum of:
  - **20 players**, and
  - **2 goalkeepers**,
  - for a total of **22**.

### **201 - CAPTAIN OF TEAM**

- a) Each team shall appoint a "**Captain**" and no more than two "**Alternate Captains**".
- b) The Captain shall wear the letter "C" and Alternate Captains shall wear the letter "A", **8 cm in height** and in a contrasting colour, in a conspicuous position on the front of their sweater.
- c) On the ice, only these designated players, if they are not penalized, shall have the privilege to discuss with the Referee any questions relating to the interpretation of rules that may arise during the course of the game.
- d) A complaint concerning a penalty is NOT a matter relating to the interpretation of the rules and shall be penalized with a Misconduct penalty (see Rule 572)

### **210 - EQUIPMENT**

- a) Players and goalkeeper's equipment shall consist of sticks, skates, protective equipment and uniforms.
- b) All protective equipment, except gloves, helmets and goalkeepers leg guards, must be worn entirely underneath the uniform.
- c) All infractions related to the wearing of equipment shall be penalized under Rule 555.
- d) Complete equipment including jerseys must be worn during the pre-game warm-up. **NEW**

### **220 - PLAYER'S EQUIPMENT**

#### **221- PLAYER'S SKATES**

The players shall wear "**Ice Hockey Skates**" with safety blades.

#### **222 - PLAYER'S STICK**

- a) Sticks shall be made of wood or other material approved by the IIHF.
- b) It shall not have any projections and all edges shall be bevelled.
- c) The top end of a hollow shaft stick must have a form of protection **NEW**
- d) Adhesive non-fluorescent tape of any color may be wrapped around the stick at any place. **NEW**
- e) Fluorescent painted sticks are not permitted and shall be removed. If a player refuses to remove the stick, access a misconduct penalty under Rule 555.

- ▶ The players stick blade may be **curved**, and the curvature shall be restricted in such a way that the distance of a perpendicular line, measured from a straight line drawn from any point at the heel to the end of the blade, shall not exceed **1.5 cm**.

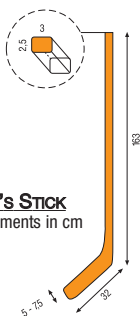

**PLAYER'S HELMET**



**PLAYER'S VISOR**



**FULL FACE MASKS**



**PLAYER'S STICK**  
All measurements in cm

- ▶ Rule 224 applies for male players; **NEW**

Born in 1993 - for season 2010/2011  
 Born in 1994 - for season 2011/2012  
 Born in 1995 - for season 2012/2013  
 Born in 1996 - for season 2013/2014

- ▶ Each national association participating in an IIHF Championship shall ensure that each of their players is equipped with a hockey helmet and where applicable, a visor or face mask, properly attached to the helmet all fit for the purpose for which they were intended by the manufacture
- ▶ The full face masks shall be constructed in such a way that neither the puck nor a stick blade might get through it

- ▶ Rule 226 applies for male and female players; **NEW**

Born in 1993 - for season 2010/2011  
 Born in 1994 - for season 2011/2012  
 Born in 1995 - for season 2012/2013  
 Born in 1996 - for season 2013/2014

f) Player's Stick Dimensions:

- 1. Shaft:** maximum length - **163 cm** from the heel to the end of the shaft  
 maximum width - **3 cm**  
 maximum thickness - **2.5 cm**  
 The shaft must be straight
- 2. Blade:** maximum length - **32 cm** from the heel to the end of the blade  
 maximum width - **7.5 cm**  
 minimum width - **5 cm**

**223 - PLAYER'S HELMET**

- During the game and during the pre-game warm-up, all players shall wear a hockey helmet with chin strap properly fastened.
- Where a player(s) fails to wear a helmet during the pre-game warm-up in International competitions, the stand by Referee shall report to the Chairman who shall report to the Directorate or the IIHF Disciplinary Committee. In National competitions, the procedure shall follow the National association rules in this matter.
- A helmet shall be worn so that the lower edge of the helmet is not more than one finger-width above the eyebrows, and there should only be enough room between the strap and the chin to insert one finger.
- Should the helmet of a player come off while play is in progress, the player shall not be permitted to participate in the play and must go directly to the player's bench. **NEW**
- If the player continues to play without his helmet he shall be penalized under Rule 555 g).

**224 - PLAYER'S FACE MASK AND VISOR**

- It is recommended that all players shall wear a full-facemask or a visor.
- Male players born after **December 31, 1974** shall wear, as a minimum, a visor.
- The visor shall extend down to cover the eyes and the lower edge of the nose in frontal and lateral projections.
- All female players shall wear full-face masks.
- All players and goalkeepers in the category under 18 years and younger shall wear a full-face mask
- Players shall not be permitted to wear coloured or tinted visor or tinted full-face mask.

**225 - PLAYERS' GLOVES**

The player's gloves shall cover hand and wrist and their palm shall not be removed to permit the use of bare hands.

**226 - NECK AND THROAT PROTECTOR**

- It is recommended that all players wear a neck and throat protector.
- All players and goalkeepers in the category under 18 years and younger must wear a neck and throat protector.



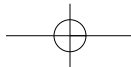

► Rule 227 applies for male players; **NEW**

Born in 1991 - for season 2010/2011  
 Born in 1992 - for season 2011/2012  
 Born in 1993 - for season 2012/2013  
 Born in 1994 - for season 2013/2014

**GOALKEEPER'S STICK**  
 All measurements in cm

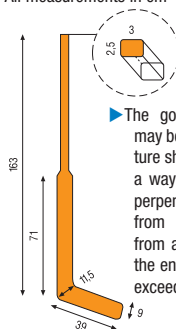

► The goalkeeper's stick blade may be **curved**, and the curvature shall be restricted in such a way that the distance of a perpendicular line, measured from a straight line drawn from any point at the heel to the end of the blade, shall not exceed **1.5 cm**.

**BLOCKER GLOVE**

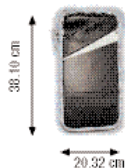

**GOALKEEPER FULL FACE MASK**

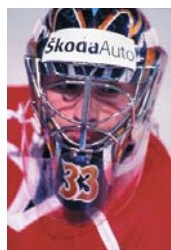

**GOALKEEPER'S SKATE**



**227 - MOUTH GUARD**

- a) It is recommended that all players wear a custom-made mouth guard.
- b) All players in the age category under 20 must wear a mouth guard.

**NEW**

**228 - ELBOW PADS**

All elbow pads which do not have a soft protective outer covering of sponge rubber or similar material of at least 1.27 cm thickness shall be considered as dangerous equipment

**NEW**

**230 - GOALKEEPER'S EQUIPMENT**

- a) With the exception of skates and stick, all the equipment worn by the goalkeeper shall be constructed solely for the purpose of protecting the head and the body and shall not include any garment or addition which would give the goalkeeper undue assistance in keeping goal.
- b) Abdominal aprons, extending down the front of the thighs on the outside of the pants, are prohibited.

**231 - GOALKEEPERS' SKATES**

The goalkeeper shall wear special **"Goalkeeper Skates"** of approved design.

**232 - GOALKEEPERS' STICKS**

- a) Sticks shall be made of wood or other material approved by the IIHF.
- b) It shall not have any projections and all edges shall be bevelled.
- c) The top end of the shaft must have a form of protection
- d) Adhesive non-fluorescent tape of any colour may be wrapped around the stick at any place.
- e) Fluorescent painted sticks are not permitted and shall be removed. If a goalkeeper refuses to remove the stick, access a misconduct penalty under Rule 555.
- f) Dimensions:
  - 1. **Shaft:** maximum length - **163 cm** from the heel  
 maximum width - **3 cm**  
 maximum thickness - **2.5 cm**  
**Widened part of the shaft:** maximum length - **71 cm** from the heel and not more than **9 cm** wide. The shaft and shank shall be straight.
  - 2. **Blade:** maximum length - **39 cm** from the heel  
 maximum width - **9 cm**, except at the heel where it shall not exceed **11.5 cm**

**NEW**

**NEW**

**233 - GOALKEEPERS' GLOVES**

**233a) - BLOCKING GLOVE**

The maximum outside dimensions of the protective padding attached to the back, forming part of a blocking glove, shall not exceed:

- **38.1 cm** in length
- **20.32 cm** in width



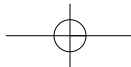

**CATCHING GLOVE**

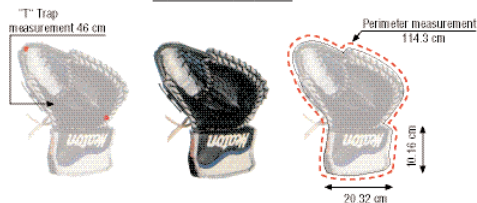

**HELMET OFF GOALKEEPER**

**LEG GUARDS**

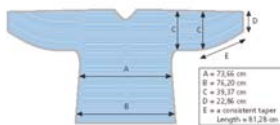
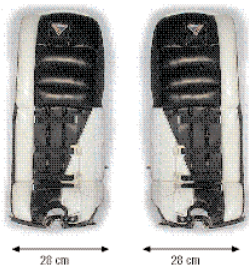

**GOALKEEPER JERSEY MEASUREMENTS**

A = 71.56 cm
B = 36.20 cm
C = 19.37 cm
D = 22.86 cm
E = a convenient taper
Length = 61.28 cm

- ▶ 1. Any player that does not comply with these provisions **shall not be permitted to participate** in the game.
- ▶ 2. If, in the opinion of the Referee, the uniform colours of the competing teams are so similar that there is the possibility of miscalling a penalty, it is the responsibility of the **home team** to change their sweaters, if ordered to do so by the Referee.
- ▶ 3. If a player's hair is long and obscures the name plate or number on the sweater, the hair shall be worn in a pony tail or under the helmet.
- NEW** ▶ 4. Graffiti type of designs, patterns or art work **shall not be permitted** on goalkeepers' pads or gloves.
- NEW** ▶ 5. Any drawings or slogans which are abusive or obscene and/or refer to cultural, racial and religion **shall not be permitted** on any type of equipment including the helmet and facemask.

**233b) - CATCHING GLOVE**

- a) The maximum outside dimensions of the catching glove shall not exceed:
  - ▶ **20.32 cm** in length in any part of the wrist cuff, which shall be **10.16 cm** in width (height)
  - ▶ Distance from the heel along the pocket to the top of the T trap shall be no more than **46 cm**.
- b) The perimeter of the catching glove shall not exceed **114.3 cm**.

**234 - GOALKEEPER'S HELMET AND FACE MASK**

- a) All goalkeepers shall wear a hockey helmet with a facemask or hockey goalkeepers head protector with a facemask. The goalkeepers facemask shall be constructed in such a way that a puck shall not get through it. **NEW**
- b) The facemask of goalkeepers in the category under 18 years of age in male and female hockey shall be constructed in such a way that neither a puck nor a stick blade can enter through the openings. **NEW**
- c) Should the helmet and facemask or the head protector and facemask come off while play is in progress, the Referee shall stop play. **NEW**
- d) Should a hard shot hit the goalkeeper's facemask, while play is in progress, the play may be stopped at the discretion of the Referee only if no immediate scoring chance is presented to the opposing team. **NEW**
- e) If a goalkeeper removes his helmet and/or facemask in order to bring a stoppage in play, the Referee shall assess the offending goalkeeper a minor penalty. **NEW**
- f) If a goalkeeper removes his helmet and/or facemask in order to bring the stoppage in play in a break away situation, the Referee shall award to the non-offending team a Penalty Shot (PS).
- g) If a goalkeeper removes his helmet and/or facemask in order to bring the stoppage in play during a Penalty Shot, the Referee shall award to the non-offending team a goal. **NEW**

**235 - GOALKEEPERS' LEG GUARDS**

- a) The goalkeeper's leg guards shall not exceed **28 cm wide** when on the leg of the goalkeeper.
- b) A piece of any material covering the space between the ice and the bottom of the leg guards in front of the skates is not permitted.

**240 - UNIFORMS**

- a) **All players** from each team shall be dressed uniformly in sweaters, pants, stockings and helmet (except of the goalkeeper who is permitted to wear a helmet of a different colour to the rest of the team).
- b) The **basic colour** shall cover approximately **80%** of each part of the equipment, excluding names and numbers.
- c) Sweaters, including the sleeves and stockings shall be of the same colour.
- d) Sweaters shall be worn outside of the pants.
- e) Each player shall wear an individual number **25cm to 30cm high** on the back of the sweater and **10cm high** on both sleeves. Numbers are limited to the numbers **1 to 99**.



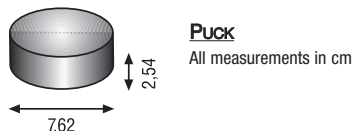

**Puck Logo**

**NEW** ▶ The printed logo, trademark and/or advertising shall not exceed in diameter 4.5 cm of the area of each side of a puck or 35% of the area of each side of the puck. There may be printing on both sides of a puck.

f) In IIHF competitions, each player shall wear his name on the upper portion of the back of his sweater, printed 10cm high, in block capital Roman letters.

### 250 - Puck

- a) The "Puck" shall be made of vulcanized rubber or other material approved by the IIHF and be primarily black in colour.
- b) The dimensions of a puck shall not exceed:
  - ▶ Diameter - **7.62 cm**
  - ▶ Thickness - **2.54 cm**
  - ▶ Weight - **156 to 170 gms**

### 260 - MEASUREMENT OF EQUIPMENT

- a) The Referee may, at any time and at his own discretion, measure any equipment.
- b) The Captain of a team may make a formal complaint against specific dimension of any equipment. The Referee shall make the necessary measurement immediately. However, no goal shall be disallowed as a result of any measurement.
- c) If the complaint is not sustained, the requesting team shall be penalized with a Bench **Minor penalty** (see Rule 555)
- d) If the complaint is sustained, the guilty player shall be penalized with a **Minor penalty** (see Rule 555)
- e) Such request shall be limited to one team at any stoppage of play.
- f) The measurement of goalkeeper's equipment, with the exception of the stick, may only be requested immediately at the end of any period.
- g) If a captain of the team that is two men short in the last two minutes of the game or in any time in overtime, requests an equipment measurement that proves to be legal equipment following the measurement, the Referee shall award to the non-offending team a **Penalty Shot** (PS).

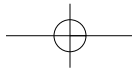

- NEW ▶** 1. Officiating systems utilised by the IIHF in an IIHF competition include the **Three-Man System** (1 referee and 2 linesmen) or the **Four-Man System** (2 referees and 2 linesmen)
- NEW ▶** 2. The duties of Referees in the Four Man System **are the same** as in the Three Man System.
- NEW ▶** 3. National Associations have the authority to use the **Two Man System** (two game officials working as both referee and linesman) in games, which are completely under their jurisdiction.

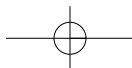

### SECTION 3 - OFFICIALS AND THEIR DUTIES

#### 300 - APPOINTMENT OF OFFICIALS

For all international games, the following officials shall be appointed:

##### GAME OFFICIALS

- One **Referee**
- Two **Linesmen**
- OR**
- Two **Referees**
- Two **Linesmen**

**NEW**

##### OFF-ICE OFFICIALS

- Two **Goal Judges**
- One **Scorekeeper** (with up to two assistants)
- One **Timekeeper**
- One **Announcer**
- Two **Penalty Bench Attendants**
- One **Video Goal Judge** (may be required at IIHF events)

#### 310 - GAME OFFICIALS

##### 311 - REFEREE AND LINESMEN EQUIPMENT

- a) All Referees and Linesmen shall be dressed in black trousers and official sweaters.
- b) All Referees and Linesmen shall wear skates and a black hockey helmet with a visor, and shall be equipped with whistle and metal tape measure with a minimum **2 metre** length.
- c) The Referee shall wear red or orange armbands, **8 to 10 cm wide**, on the upper part of each sleeve (only in the three or the four man system).

##### 312 - REFEREE DUTIES

The Referee shall have general supervision of the game, full control of game officials and players, and his decision shall be final in case of any dispute.

##### 313 - LINESMEN DUTIES

- a) The Linesmen shall be responsible mainly for the infractions concerning the lines (off-side, icing the puck).
- b) They shall face-off the puck in most circumstances and will assist the Referee in conducting the game.
- c) The complete duties of the Referee and Linesmen are outlined in Annex 4.



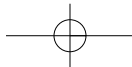

- ▶ If, after the start of the game, it becomes apparent that a Goal Judge is guilty of giving unjust decisions, the Referee shall appoint another Goal Judge.

### **320 - OFF-ICE OFFICIALS**

#### **321 - GOAL JUDGE**

- a) There shall be one goal judge stationed behind each goal. The Goal Judges shall not change goals during the game. In IIHF competitions they may not be nationals of either team engaged in the game.
- b) The Goal Judge shall decide **only if the puck has passed between the goal posts and completely over the goal line**, and shall then give the appropriate signal.
- c) The **Referee** may consult with the Goal Judge, but the **Referee shall give the final decision** in matters of a disputed goal.

#### **322 - SCOREKEEPER**

The complete duties of the Scorekeeper are outlined in Annex 4.21 to 4.23.

#### **323 - TIMEKEEPER**

The complete duties of the Timekeeper are outlined in Annex 4.24

#### **324 - ANNOUNCER**

The complete duties of the Announcer are outlined in Annex 4.25.

#### **325 - PENALTY BENCH ATTENDANT**

There shall be one Penalty Bench Attendant per team penalty bench. The complete duties of the Penalty Bench Attendant are outlined in Annex 4.26

- ▶ See Video Goal Judge System in the IIHF Sport Regulations.



**REFEREE DISCUSSING WITH VIDEO GOAL JUDGE**

#### **330 - VIDEO GOAL JUDGE SYSTEM**

- a) Video Goal Judge System (VGJ) shall be applied only by at the request of the Referee or the Video Goal Judge.
- b) The following are the only situations subject to review by the Video Goal Judge:
  1. Puck crossing the goal line.
  2. Puck in the net prior to the goal frame being displaced.
  3. Puck in the net prior to or after the expiration of time at the end of a period.
  4. Puck directed into the net by hand or kicked into the net.
  5. Puck deflected into the net off a game official.
  6. Puck struck with a high stick above the height of crossbar by an attacking player prior to entering the net.
  7. Establishing the correct time on the official clock, provided the game time is visible on the Video Goal Judge's monitor.

#### **340 - PROPER AUTHORITIES**

The term "**Proper Authorities**" or "**Proper Disciplinary Authorities**" as applied under these rules, is defined as the immediate governing body of the games involved.



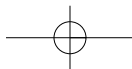

- ▶ 1. Each team shall be allowed to have only one goalkeeper on the ice at one time while play is in progress.
- ▶ 2. This goalkeeper may be removed and substituted by a player. However, such player shall not be permitted the privileges of the goalkeeper.

- ▶ 1. If the home team has not been established, the competing teams shall decide which team shall be the home team by mutual agreement, by the flip of a coin or some similar method.
- ▶ 2. **Home team privileges:**
  1. Choice of the players bench,
  2. Choice of uniform colours.
  3. At the face-off following a stoppage of play, the home team shall place its line-up on the ice after the visiting team.
- ▶ 3. At any time in the game, the Referee may request, through the Captain, that the visiting team put a playing line-up on the ice to promptly commence play.

- ▶ 1. No warm-up shall be allowed to any player or goalkeeper at the end of the first and second period, or at any stoppage of play.
- ▶ 2. Teams shall not change ends when the ice is not resurfaced for overtime or game winning shots.
- ▶ 3. In the application of the rule, the change of one or more players shall constitute a line change.

**CHANGING AREA FOR PLAYERS**  
All measurements in cm

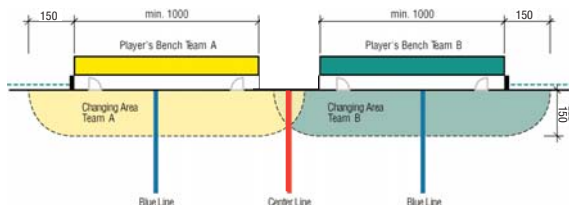

**SECTION 4 - PLAYING RULES**

**400 - PLAYERS ON THE ICE**

A team shall not have more than **six players** on the ice at any time while play is in progress.

- ▶ **Bench Minor** penalty for Too Many Players on the Ice (Rule 573).

The six players shall be:



**402 - START OF GAME AND PERIODS**

- a) The game shall begin at the scheduled time with a face-off at the center face-off spot. A face-off conducted in the same manner shall take place at the start of each period.
- b) The teams shall start the game defending the goal nearest to their player bench.
- c) Teams shall change ends for each succeeding regular or overtime period.

**411 - CHANGE OF PLAYERS AND GOALKEEPERS FROM THE PLAYER'S BENCH DURING PLAY**

**NEW**

- a) The players and Goalkeepers may be changed at any time from the players bench while the game is in progress provided that:
  1. The changing players and Goalkeepers are within an imaginary area limited by the length of the respective players bench and 1.5 metres from the boards, as illustrated on the opposite page.
  2. The changing players and Goalkeepers are out of the play before any change is made.
  3. A team that is in violation of icing shall not be permitted to make any player substitutions prior to the ensuing face-off. (see Rule 460)
- b) If, during a substitution, the player entering the game plays the puck or makes any physical contact with an opponent while the retiring player is actually on the ice, there shall be a Bench Minor penalty for Too Many Players on the Ice (Rule 573).
- c) If, during a substitution, the goalkeeper departing the ice plays the puck or makes any physical contact with an opponent while the entering player is actually on the ice, the Referee shall assess a Bench Minor penalty for Too Many Players on the Ice (rule 573)
- d) If during the substitution, either the entering player or retiring player is struck accidentally by the puck, the play shall not be stopped and no penalty called.
- e) If a goalkeeper leaves his crease and proceeds to his player's bench for the purpose of substituting another player and if the substitution is made prematurely, the Referee shall stop the play when the offending team gains possession of the puck. The ensuing face-off shall take place at the centre ice face-off spot when play is stopped beyond the center red line. When play is stopped prior to the play reaching the center red line, the resulting face-off shall be conducted at the nearest face-off spot in the zone where the play was stopped.

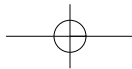

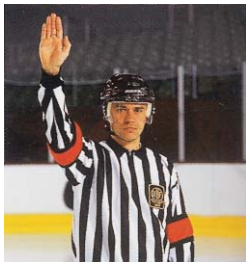

**PLAYER CHANGE SIGNAL RULE 412**

**412 - CHANGE OF PLAYERS PROCEDURE DURING STOPPAGE OF PLAY**

- a) Following a stoppage of play, the visiting team shall promptly place a line-up of players on the ice for play and no substitution shall be made until play has resumed. The home team may then make any desired substitution, which does not result in the delay of the game. If there is any undue delay by either team in changing lines, the Referee shall order the offending team or teams to take their positions immediately and shall not permit a line change.
- b) The procedure shall be carried out as follows:
  - 1. The Referee shall take his position for the start of the next play, and the Linesman dropping the puck shall proceed promptly to the location of the face-off.
  - 2. The Referee shall allow the visiting team **five seconds** to make their player changes.
  - 3. After the **five seconds**, the Referee shall raise his arm to indicate that the visiting team shall no longer make a player change.
  - 4. With the arm still up, the Referee shall allow the home team **five seconds** to make their player changes.
  - 5. After the **five seconds**, the Referee shall drop his arm to indicate that the home team shall no longer make a player change.
  - 6. As soon as the Referee drops his arm, the Linesman conducting the face-off shall blow the whistle, which signals both teams that they shall have no more than **five seconds** to line-up for the face-off.
  - 7. At the end of the **five seconds**, or sooner if the facing-off players are ready, the Linesman shall drop the puck. It shall not be the responsibility of the Linesman to wait for the players to come into position for the face-off.
- c) When a team attempts to make a player change after its allotted period of time, the referee shall send the player(s) back to the bench and issue a warning to the coach. Any subsequent infraction of this procedure at any time during the course of the game shall result in the team receiving a: **Bench Minor penalty** (see Rule 575). NEW
- d) Teams are not permitted to make player's substitution following a false face off, except when a penalty is assessed that affects the on ice strength of either team.
- e) Following a stoppage of play for an icing infraction, the offending team is prohibited from making any player change until play has resumed.
- f) A team that is in violation of this rule shall not be permitted to make any player substitutions prior to the ensuing face-off. Should the stoppage of play following the icing infraction coincide with a commercial time-out, or should the offending team elect to utilize their team time-out at this stoppage of play, they are still not permitted to make any player substitutions. However, a team shall be permitted to make a player substitution to replace a goalkeeper who had been substituted for an extra player, to replace an injured player or goalkeeper, or when a penalty has been assessed that affects their on-ice strength. The determination of players on ice will be made when the puck leaves the offending player's stick.
- g) If a team persists in changing players after they have iced the puck, and warned by the Referee, the Referee shall assess to the offending team a: **Bench Minor penalty** (2').

▶ This penalty shall be announced as a "Bench Minor Penalty for the Delay of Game - Violation of change of players after icing the puck".

▶ This penalty shall be announced as a "Bench Minor Penalty for the Violation of Change of Players from the Penalty Bench".

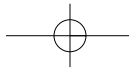

▶ This penalty shall be announced as a "Bench Minor Penalty for the Violation of Change of Players from the Penalty Bench".

- ▶ 1. This penalty shall be announced as a "Bench Minor Penalty for the Delay of the Game - Violation of Change of Goalkeepers during stoppage of Play".
- ▶ 2. **No warm-up** shall be permitted for a substitute goalkeeper.

▶ 1. If it is obvious that a player has sustained a serious injury, the Referee and/or the Linesman shall stop the play immediately.

- ▶ 1. **No warm-up** shall be permitted for the substitute goalkeeper.
- ▶ 2. In this case, neither of the two regular goalkeepers shall return to the game.
- ▶ 3. In IIHF competitions where 3 goalkeepers are registered and one of the two goalkeepers on the Game Sheet is incapacitated, the applicable IIHF By-Law applies.

**413 - CHANGE OF PLAYERS FROM THE PENALTY BENCH**

A player serving a penalty, who is to be changed after the penalty has been served shall proceed at once, by way of the ice, and be at his own player's bench before any change can be made. **NEW**

▶ **Bench Minor** penalty

**415 - CHANGE OF GOALKEEPERS DURING STOPPAGE OF PLAY**

a) During a stoppage of play, goalkeepers shall not be permitted to go to the players' bench except to be replaced or during a time out.

▶ **Bench Minor** penalty ( Rule 592)

b) When a goalkeeper substitution has been made during a stoppage of play or a time-out, the goalkeeper who left the game may re-enter the game as soon as the play resumes.

**416 - INJURED PLAYERS**

a) If a player is injured and cannot continue to play or go to the bench, the play shall continue until his team has secured possession of the puck, unless this team is in a scoring position.

b) If a player other than the goalkeeper is injured or compelled to leave the ice during the game, he may retire and be replaced by a substitute, but play shall continue without the teams leaving the ice.

c) If a penalized player has been injured he may proceed to the dressing room, and if he has been assessed a Minor, Major or Match penalty, the penalized team shall immediately put a substitute player on the penalty bench who shall serve the penalty without change, except by the injured penalized player if he is able to return.

d) The injured penalized player shall not be eligible to play until his penalty has expired.

e) If an injured player returns to play before his penalty has expired, the Referee shall assess additionally to this player a

▶ **Minor** penalty (2')

f) When play has been stopped due to an injured player, excluding the goalkeeper, the injured player shall leave the ice and shall not return to the ice until after play has resumed. Should he return earlier then a Minor penalty (2') is assessed (see Rule 554e) **NEW**

**417 - INJURED GOALKEEPERS**

a) If a goalkeeper sustains an injury or becomes ill, he shall be ready to resume play immediately or be replaced by a substitute goalkeeper.

b) If both goalkeepers of the team are incapacitated and unable to play, the team shall have **ten minutes** to dress another player in uniform as a goalkeeper.

**419 - ICE CLEANING**

a) A Referee or a Linesman has the authority to remove a build up of snow around the goal post or on the goal line near the net. **NEW**

b) If a goalkeeper deliberately piles snow or obstacles at or near his net that in the opinion of the Referee would tend to prevent the scoring of a goal he shall be assessed a:

▶ **Minor** penalty (2') **NEW**





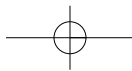

- ▶ 1. Playing time shall commence from the instant the puck is faced-off and shall stop when the whistle is blown.
- ▶ 2. If any unusual delay occurs within **five minutes** of the end of the first and second period, the Referee may order the next regular intermission to be taken immediately. When play resumes, the remaining time shall be played with the teams defending the same goal as before the intermission, after which time the teams change ends and resume playing the ensuing period without delay.
- ▶ 3. In open air rinks, teams shall change ends at the midway point of the third and overtime periods.
- ▶ 4. During the intermissions the ice shall be resurfaced.
  
- ▶ 1. With respect to goalkeepers, goalkeepers may be changed after each alternate shot has been taken, however, where a Shot has to be repeated, the same Goalkeeper must remain in the goal and the same player must repeat the shot until it is completed.
- ▶ 2. When a player and goalkeeper has been selected by their respective coaches to take a shot or defend the net against this shot, such player and/or goalkeeper cannot be changed if the Shot shall be repeated due to a violation or a foul committed by the goalkeeper unless such player and/or goalkeeper received an injury and cannot participate in the Penalty Shot Procedure. In this case the Coach may designate another player to take a Shot or the other goalkeeper to defend the net.

- ▶ No music can be played in the arena during a team Time-out



**TIME-OUT SIGNAL  
RULE 422**

- ▶ **“Sudden Death”** means that the overtime period is finished when a team scores the first goal

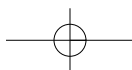

**420 - TIMING OF GAME**

**NEW**

- a) The regular game shall consist of three 20 minute stop time periods and two 15-minute intermissions.
- b) The full 60 minute game duration shall be referred to as 'Regulation Time'.
- c) The teams shall change ends for each period of Regulation Time.

**421 - OVERTIME PERIOD**

**NEW**

In a game where a winner shall be declared, and the game is tied after Regulation Time, the game shall be prolonged by a sudden death overtime period. If no goal is scored in the overtime period, game winning shots shall be used to determine the winner.

**422 - TIME-OUT**

- a) Each team shall be permitted one **30 second time-out** during the course of Regulation Time or during Overtime. **NEW**
- b) During a normal stoppage of play, any player designated by the Coach may ask the Referee for the time-out. The Referee shall report the time out to the Scorekeeper.
- c) The players and goalkeepers of both teams, except for penalized players, are allowed to go to their respective benches
- d) Each team may take their time-out at the same stoppage of play, but the team taking the second time-out shall notify the Referee before the end of the first time-out.

**430 - DETERMINING THE OUTCOME OF THE GAME**

**NEW**

- a) The team scoring the greatest number of goals during Regulation Time of a regular game shall be declared the winner and shall be awarded with three points.
- b) If, at the end of Regulation Time of a regular game, the score for both teams is equal, each team will be awarded one point and the game will continue with a sudden death overtime period
- c) The winning team in the sudden death overtime period of a regular game will receive an additional point
- d) If neither team scores in the sudden death overtime period then Game Winning Shots will be applied
- e) The winning team in the Game Winning Shots of a regular game will receive an additional point
- f) In a playoff game where a winner shall be declared, the game shall be prolonged by a **“Sudden Death”** overtime period. If no goal is scored during the overtime period then game winning shots shall be used to determine the winner.

**FACE-OFF SPOTS**

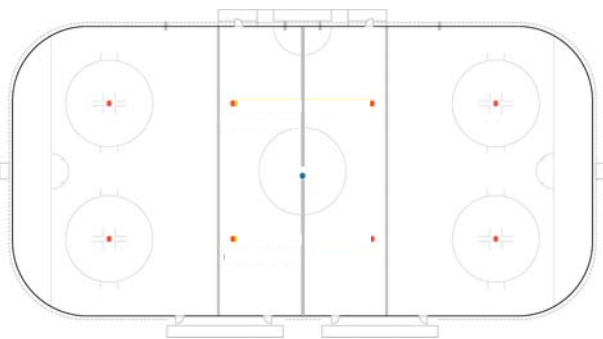

**440 - FACE-OFFS**

- a) A face-off shall be conducted **at the beginning of each period and after any stoppage of play.** **NEW**
- b) All face-offs will only be conducted at the nine designated face-off spots
- c) Face-offs shall be conducted at the **center ice spot**:
  1. At the start of a period,
  2. After a goal scored,
  3. After an error by an official on icing,
  4. For premature substitution of a goalkeeper unless otherwise expressly provided by these rules (See Rule 411e)
- d) When a stoppage of play has been caused by any player of the attacking side in the attacking zone, the ensuing face-off shall be made in the neutral zone on the nearest face-off spot. If two rule violations are the reason for the stoppage of play (ie. high-sticking the puck and intentional off-side), the ensuing face-off location shall be determined as the spot that provides the least amount of territorial advantage to the offending team.
- e) When the play is stopped for any reason not specifically attributable to either team while the puck is in the neutral zone, the ensuing face-off shall be conducted at the nearest face-off spot outside the blue line whenever possible. When it is unclear as to which of the four face-off spots is the nearest, the spot that gives the home team the greatest territorial advantage in the neutral zone will be selected for the ensuing face-off.
- f) When an infringement of a rule has been committed by players of both sides in the play resulting in the stoppage, the ensuing face-off will be made at the nearest face-off spot in that zone
- g) When players are penalized at a stoppage of play so as to result in penalties being placed on the penalty time clock to one team, the ensuing face-off shall be conducted at one of the two end zone face-off spots in the offending team's end zone. There are only four exceptions to this application:
  1. When a penalty is assessed after the scoring of a goal - face-off at Centre Ice
  2. When a penalty is assessed at the end (or start) of a period - face-off at Centre Ice
  3. When the defending team is about to be penalized and the attacking players enter the attacking zone beyond the outer edge of the end zone face-off circles - face-off in the Neutral Zone
  4. When the team not being penalized ices the puck, the face-off in the neutral Zone outside the blue line of the team icing the puck
- h) When stoppage occurs between the end face-off spots and near end of the rink, the puck shall be faced-off at the end face-off spot on the side where the stoppage occurs unless otherwise expressly provided by these rules.
- i) When a goal is illegally scored as a result of a puck being deflected directly off an official anywhere in the defending zone, the resulting face-off shall be made at the end face-off spot in the defending zone.
- j) When the game is stopped for any reason not specifically covered in the official rules, the puck must be faced-off at a face-off spot in the zone nearest to where it was last played.
- k) Following a stoppage of play, should one or both defensemen who are the point players or any player coming from the bench of the attacking team, enter into the attack-

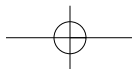

- ▶ 1. The whistle shall not be blown by the official to start play.
- ▶ 2. No substitution of players shall be permitted until the face-off has been conducted and play has resumed, except when a penalty is assessed that shall affect the on ice strength of either team.
- ▶ 3. If the player facing-off fails to take his proper position immediately when directed to do so by the official, the official may order him replaced for the face-off by another team mate on the ice.
- ▶ 4. If a player enters the face-off circle, the Referee or Linesman shall blow the whistle to re-face-off the puck, unless the non-offending team gains possession of the puck.
- ▶ 5. The Referee shall assess the corresponding **penalty(s)** or the infraction made by the player (See Rule 554g paragraph b).

**OFFSIDE PASS SITUATIONS**

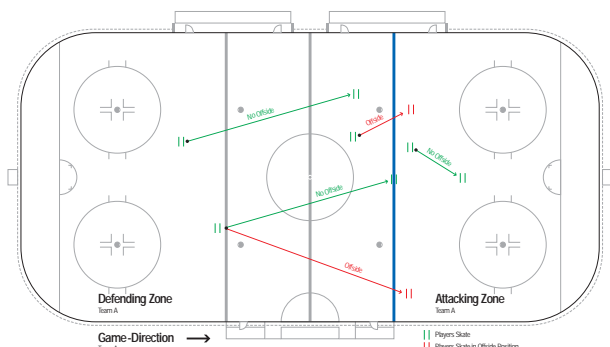

- ▶ 1. If a defending player carries or passes the puck into his defending zone while a player of the attacking team is in an offside position, no offside will be called.
- ▶ 2. An **intentional offside** is made for the purpose of causing a stoppage of play, regardless of the reason.

ing zone beyond the outer edge of the end zone face-off circle during an altercation, gathering or "scrum," the ensuing face-off shall take place in the neutral zone near the blue line of the defending team. This rule also applies when an icing, an intentional off-side, or a high-sticking the puck violation. Should any of the non-offending players enter into the attacking zone beyond the outer edge of the end zone face-off circle during an altercation, gathering or "scrum," the ensuing face-off shall take place in the neutral zone near the blue line of the defending team.

- l) For a violation of Rule 411e, the resulting face-off will take place at the center ice face-off spot when play is stopped beyond the center red line. When play is stopped prior to the center red line, the resulting face-off shall be conducted at the nearest face-off spot in the zone where the play was stopped.
- m) When play is stopped for an injured player, the ensuing face-off shall be conducted at the face-off spot in the zone nearest the location of the puck when the play was stopped. When the injured player's team has possession of the puck in the attacking zone, the face-off shall be conducted at one of the face-off spots outside the blue line in the neutral zone. When the injured player is in his defending zone and the attacking team is in possession of the puck in the attacking zone, the face-off shall be conducted at one of the defending team's end-zone face-off spots.

**442 - PROCEDURE FOR CONDUCTING FACE-OFFS**

- a) The Referee or the Linesman shall drop the puck between the sticks of the two players facing off.
- b) The players shall be positioned squarely facing their opponent's end of the rink, approximately one stick length apart, with the blade of their stick on the ice on the white part of the face-off spots.
- c) The player of the attacking team in his attacking half of the rink shall place his stick on the ice first followed immediately by the player of the defending team.
- d) However, when the face-off is at the centre ice spot the player of the visiting team shall place his stick first on the ice.

**450 - OFFSIDES**

- a) Players of an attacking team **shall not precede the puck** into their attacking zone.
- b) The determining factors in deciding an offside are:
  1. The **player's skates position** - player is offside when both skates are completely over the blue line in his attacking zone before the puck completely crosses the line,
  2. The **puck position** - the puck shall have completely crossed the blue line into the attacking zone.
  3. If a player is propelling the puck and crosses the line ahead of the puck while skating backward, the player is not offside provided he is actually in control of the puck and has both skates in the neutral zone before crossing the blue line

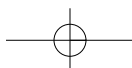

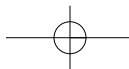

- ▶ 1. The attacking zone shall be completely clear of attacking players before the delayed offside can be nullified with the puck still in the attacking zone.
- ▶ 2. **"Immediately"** means that the attacking players shall not touch the puck, or attempt to gain possession of a loose puck, or force the defending puck carrier further back in the zone.
- ▶ 3. In this second case, when the Linesman drops his arm, any attacking player may re-enter his attacking zone.

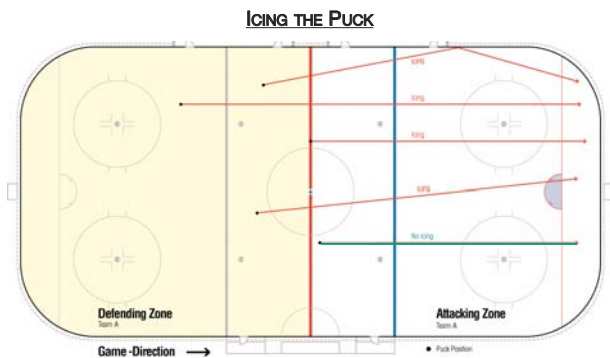

- ▶ 1. If the Linesmen have erred in calling an icing, the puck shall be faced-off on the center ice face-off spot.
- ▶ 2. The purpose of this section is to enforce continuous action and both Referee and Linesmen should interpret and apply the rule to produce this result.
- ▶ 3. **"Short Handed"** means that due to a penalty(s), the team must be below the numerical strength of its opponents on the ice.

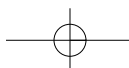

- c) In violation of this rule, play shall be stopped and a face-off shall be conducted:
  1. At the nearest neutral zone face-off spot, if the puck was carried over the blue line by the attacking player.
  2. At the nearest face-off spot where the pass or shot originated when the puck was passed or shot over the blue line by the attacking player. **NEW**
  3. At the end face-off spot in the defending zone of the offending team if, in the opinion of the Linesman or Referee, a player has intentionally caused an offside.
  4. At the end zone face-off spot in the defending zone of the offending team, if the puck was passed or shot by the attacking player from his defending zone.

**451 DELAYED OFFSIDE PROCEDURE**

If an attacking player precedes the puck into the attacking zone, but a defending player is able to play the puck, the Linesman shall raise his arm to signal a **"Delayed Offside"**, except if the puck has been shot on goal causing the goalkeeper to play the puck.

The Linesman shall drop his arm to nullify the offside violation and allow the play to continue if:

1. The defending team either passes or carries the puck into the neutral zone,
2. Or, all attacking players **immediately** clear the attacking zone by making skate contact with the blue line.

**460 - ICING THE PUCK**

- a) For the purpose of this rule, the centre red line divides the ice rink into two halves. The point of last contact with the puck by the team in possession shall be used to determine whether or not icing has occurred.
- b) Should a player of a team equal or superior in numerical strength shoot, bat or deflect the puck from **his own half of the ice beyond the goal line** of the opposing team, play shall be stopped and icing shall be called.
- c) A face-off will take place at the end zone face-off spot of the offending team nearest to where they last touched the puck. **NEW**
- d) **No icing** shall be called:
  1. If the puck enters the goal - the goal is allowed,
  2. If the offending team is **"Short Handed"** at the instant the puck is shot,
  3. If the puck touches any part of an opposing player, including the goalkeeper, before crossing the goal line,
  4. If the puck is iced directly from a player participating in a face-off,
  5. If, in the opinion of the Linesman, any player from the other team, except the goalkeeper, is able to play the puck before it crosses the goal line.
  6. Once the goalkeeper leaves his goal crease or when the goalkeeper is outside his goal crease during icing situation and moves in the direction of the puck.
- e) Following a stoppage of play for an icing infraction, the offending team is prohibited from making any player change until play has resumed. **NEW**

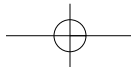

- ▶ This penalty shall be announced as a "Bench Minor Penalty for the Delay of the Game - Violation of Change of Players after Icing the Puck".



**PUCK IN THE NET**

- ▶ 1. Only one goal can be awarded to one team at any single stoppage during the course of any game.
  - ▶ 2. The 'lacrosse-like' move whereby the puck is picked up on the blade of the stick and 'whipped' into the net shall be permitted provided the puck is not raised above the height of the shoulders at any time and when released, is not carried higher than the crossbar.
  - ▶ 3. All such calls shall be based strictly on the judgement of the Referee
- 
- ▶ 1. No goal shall be disallowed after the face-off immediately following the scoring of that goal.
  - ▶ 2. The goal crease is defined as a **volume**, extending from the crease area on the ice up to **1.27 m** above the ice surface.
  - ▶ 3. **"Contact"** whether or otherwise, between a goalkeeper and an attacking player may be with the stick or any part of the body.
  - ▶ 4. All such calls shall be based strictly on the judgement of the Referee

- f) A team that is in violation of this rule shall not be permitted to make any player substitutions prior to the ensuing face-off. Should the stoppage of play following the icing infraction coincide with a commercial time-out, or should the offending team elect to utilize their team time-out at this stoppage of play, they are still not permitted to make any player substitutions. However, a team shall be permitted to make a player substitution to replace a goalkeeper who had been substituted for an extra player, to replace an injured player or goalkeeper, or when a penalty has been assessed that affects their on-ice strength. The determination of players on ice will be made when the puck leaves the offending player's stick **NEW**
- g) If a team persists in changing players after they have iced the puck, and warned by the Referee, the Referee shall assess to the offending team a **NEW**
  - ▶ **Bench Minor** penalty (2')

**470 - DEFINITION OF A GOAL**

A goal shall be allowed:

1. When the puck has been put between the goal posts below the crossbar and entirely across the goal line by the stick of a player of the attacking team.
2. If the puck has been put into the goal net in any way by a player of the defending team.
3. If the puck has been deflected into the goal net from the shot of an attacking player by striking any part of a teammate.
4. If a player of the attacking team has been physically interfered by the action of any defending player so as to cause him to be in the goal crease when the puck enters the goal net, unless if in the opinion of the Referee, he had sufficient time to get out of the crease.
5. If the puck should become loose in the goal crease and then put into in the goal by the stick of the attacking player,
6. When the puck deflects directly off the skate of an attacking or defending player.
7. If an attacking player being in the goal crease at the moment the puck crosses a goal line and in NO WAY affect the goalkeeper's ability to make a save, unless the cases describing in Rule 471.

**471 - DISALLOWING A GOAL**

a) **No goal** shall be allowed:

1. If an attacking player deliberately kicks, throws or bats with the hands or otherwise directs the puck by any means other than his stick into the goal net even if the puck has been further deflected by any player, goalkeeper or official,
2. If an attacking player contacted the puck with the stick above the cross bar,
3. If the puck has been directly deflected into the goal net off an official,
4. If an attacking player stands or holds his stick in the goal crease when the puck enters the goal net, unless he has been physically interfered with, by the action of any defending player so as to cause him to be in the goal crease when the puck enters the goal net, unless if in the opinion of the Referee, he had sufficient time to get out of the crease or unless Rule 470 applies.
5. If the goal net has been displaced from its normal position, or the frame of the goal net is not completely flat on the ice.



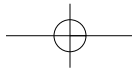

- ▶ 1. Only one point shall be awarded to any one player on a goal.
- ▶ 2. Two assists may be awarded when a player scores after a rebound off of the goalkeeper.
- ▶ 3. In the case of an obvious error in awarding a goal or assist, the error shall be corrected promptly, but changes shall not be made once the Referee has signed the **Official Game Sheet**.

- 6. If an attacking player initiates contact with the goalkeeper, incidental or otherwise, while the goalkeeper is in his goal crease and a goal is scored.
  - 7. If an attacking player initiates any contact with the goalkeeper, other than incidental contact, while goalkeeper is outside his goal crease and a goal is scored.
  - 8. Where an attacking player enters or takes a position within the goal crease, so as to obstruct the goalkeeper's vision and impair his ability to defend his goal net and a goal is scored.
  - 9. Where a goalkeeper has been pushed into the goal net together with the puck after making a stop. If applicable, appropriate penalties shall be assessed.
- b) Where the puck is under the player who is in or around the goal crease (deliberately or otherwise), a goal cannot be scored by pushing this player together with the puck into the goal net. If applicable, the appropriate penalties shall be assessed, including the Penalty Shot (See Rule 557).

#### **472 - GOAL AND ASSIST AWARDED TO THE PLAYER**

- a) A "**Goal**" shall be credited in the scoring records to the player who propelled the puck into the opponent's net.
- b) Each goal shall count **one point** in the player's statistical record.
- c) When a goal has been scored, an "**Assist**" shall be credited to the player(s) taking part in the play immediately preceding the action.
- d) No more than two assists can be given on any goal.
- e) Each assist shall account for **one point** in the player's statistical record.

#### **480 - PUCK OUT OF BOUNDS**

**NEW**

When the puck goes outside the playing area or strikes any obstacles, other than the boards or protective glass above the ice surface, the play shall be stopped and the face-off shall take place at the nearest point on the face-off spot where the puck was shot or deflected, unless expressly provided in these rules.

#### **481 - PUCK ON THE NET**

When the puck is lodged in the outside netting of the goal net for more than **three seconds** or frozen against the goal net between opposing players, the Referee shall stop the play and face-off the puck:

- 1. At the nearest end zone face-off spot if, in the opinion of the Referee, the stoppage **NEW** has been caused by an defending player.
- 2. At the nearest neutral zone face off-spot if, in the opinion of the Referee, the stoppage has been caused by an attacking player.

#### **482 - PUCK OUT OF SIGHT**

**NEW**

Should a scramble take place or a player accidentally fall on the puck and the puck is out of sight of the Referee, he shall immediately stop the play, and the puck shall be faced-off at the nearest face-off spot to where the play has been stopped, unless provided for in the rules.



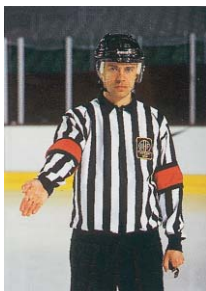

**HAND PASS SIGNAL  
RULE 490**

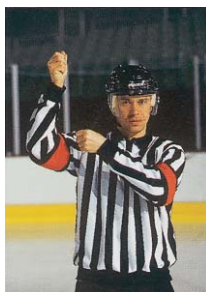

**HIGH STICKING THE PUCK SIGNAL  
RULE 492**

**483 - ILLEGAL PUCK**

If, at any time, while play is in progress, a puck other than the one legally in play shall appear on the playing surface, the play shall not be stopped until the play then in progress is completed by change of **possession**.

**484 - PUCK STRIKING AN OFFICIAL**

Play shall not be stopped because the puck touches an official except when the puck has entered the goal.

**490 - STOPPING/PASSING THE PUCK WITH HANDS**

A player shall be permitted to stop or bat the puck in the air with the open hand or push it along the ice with his hand and the play shall not be stopped, unless in the opinion of the Referee, the player has deliberately directed the puck to a team-mate or has allowed his team to gain an advantage and subsequently possession and control of the puck is obtained by a player of the offending team, either directly or deflected off any player or official. A player shall be permitted to catch the puck out of the air but must immediately place it or knock it down to the ice. If he catches it and skate with it, either to avoid a check or to gain a territorial advantage over his opponent he shall be assessed a:

▶ **Minor** penalty (2') (see Rule 559)

- a) When a hand pass violation has occurred the play shall be stopped and the ensuing face-off shall take place at the nearest face off spot in the zone where the offence occurred, unless the offending team gains a territorial advantage, then the face-off shall be at the nearest face off spot in the zone where the stoppage of play occurred unless otherwise covered in the rules. **NEW**
- b) If a teammate of such a player obtains possession of the puck in his Defending Zone, the Referee shall not stop the play provided the hand pass is completed before the player and puck leave the zone. However when the puck is passed with the hand from a player in the Neutral Zone to a teammate in his Defending Zone, the Referee shall stop the play with the Face-off at the face-off spot in the Defending Zone. **NEW**
- c) If a teammate of such player obtains possession of the puck in his Attacking Zone, the Referee shall stop the play, with the Face-off at the Neutral zone face-off spot outside the Attacking zone.
- d) A goal shall be disallowed if the puck was batted by an attacking player even deflected into the goal by any player or his stick, goalkeeper or official into the goal.
- e) A goal shall be disallowed if the puck was batted by an attacking player even if deflected into the goal by any player or his stick or skate, goalkeeper or official into the goal.

**492 - HIGH STICKING THE PUCK**

- a) **Stopping or batting the puck with the stick above the height of the shoulders is prohibited**, and the play shall be stopped, unless:
  1. The puck is batted to an opponent in which case the play shall continue and the Referee shall give the **"Wash Out"** signal.
  2. A player of the defending team bats the puck in his own goal, in which case the goal is allowed.



**WASH-OUT SIGNAL**

- b) If the puck has been high-sticked by an attacking player in his Attacking Zone the face-off shall take place at the nearest spot in the Neutral Zone.
- c) If the puck has been high stucked by a player in his Defending Zone or in the Neutral Zone, the face-off shall take place at the nearest Defending Zone face-off spot. **NEW**
- d) No goal can be scored when the puck is high stucked into the net with a stick of the attacking team where the point on the stick where the puck hit the stick is above the height of the crossbar and the puck was propelled into the net. **NEW**

**493 - INTERFERENCE BY SPECTATORS**

- a) In the event that objects are thrown on to the ice, which interferes with the progress of the game, the Referee shall stop the play and the puck shall be faced-off at the nearest face-off spot where the play was stopped. **NEW**
- b) In the event of a player being held or interfered with by a spectator, the Referee or the Linesman shall stop the play. If the team of the player interfered with is in possession of the puck, the play shall be allowed to be completed.
  - ▶ **Report** to the Proper Authorities.